

SCO Operating System support of hp StorageWorks Modular Smart Array



Table of Contents

- MSA1500 2
- MSA1000 4
- MSA30 6
- MSA20 7
- MSA support for SCO Operating Systems – Supported Components..... 8
 - Hardware 8
 - Software 9
- Firmware Upgrade for MSA1000 and MSA1500 10
- MSA Deployment..... 11
- Connecting MSA to ProLiant servers running SCO operating systems 11
 - Figure 1. Single Server (Single Path) using the Fibre Channel I/O Module (Direct)..... 12
 - Figure 2. A Typical MSA1000 Configuration using MSA SAN Switch 2/8..... 12
 - Figure 3. A Typical Configuration with a Server and MSA1000 using MSA Hub 2/3..... 13
 - Figure 4. A Typical Single-Path Configuration..... 13
 - Figure 5. A Typical Multi-Path Configuration 14
- Configuring logical volumes on the MSA 15
- Installing the HBA Driver..... 16
- Configuring MSA LUNs in SCO Operating System 17
- Limitations..... 18
- For more information..... 19

MSA1500



MSA1500 with MSA30
and MSA20 enclosure

The MSA1500 provides scalability and performance at a reduced cost with a high return on investment, and with the ability to manage more data with less staffing and increased computing infrastructure utilization for better overall system performance.

Key features of the MSA1500:

- Low cost, highest scalability capacity, supports MSA20 & MSA30
- Both SCSI and SATA drive support
- Easy management

MSA1500 Overview

The HP StorageWorks 1500cs Modular Smart Array (MSA1500) is a Fibre Channel storage area network (SAN) 2U controller shelf that connects to HP StorageWorks Serial ATA (SATA) and/or SCSI disk enclosures. They provide customers with a flexible low-cost, high capacity storage solution. The MSA1500cs has been designed as a hardware foundation for future solutions to ensure maximum investment protection. The MSA1500cs is perfect for those customers looking for less expensive storage solutions using HP SATA enclosures to store data that doesn't require a high degree of I/O performance and/or is viewed as non-mission critical to business operations. The MSA1500cs with up-to-eight attached SATA enclosures can provide the customer with up to 48 TB (96 - 500 GB SATA disk drives) of native capacity. If the business needs enterprise-class SCSI reliability then attach up-to-four SCSI enclosures for a native capacity of 16.8 TB (using 56 - 300 GB SCSI disks).

By using existing SCSI drive enclosures, MSA1000 controller technology, and integrating low cost SATA hard drives and enclosures, the MSA1500cs lowers the total cost of ownership and protects the customer's hardware investments.

MSA1500 cs Features

Two views of the MSA1500 cs are shown, with the key components identified.

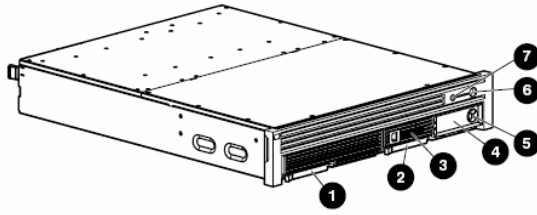

MSA1500 cs (Front View)

Reference #	Identifier
1	Redundant controller slot blank
2	Primary controller
3	Status indicators
4	Display panel
5	Display push buttons
6	Power switch
7	Unit ID button and indicator

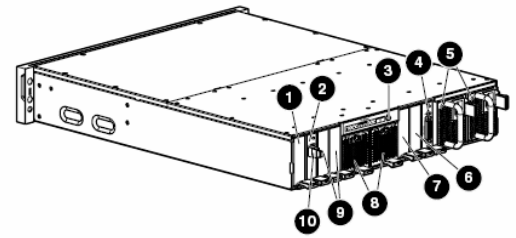

MSA1500 cs (Rear View)

Reference #	Identifier
1	Reserved for future use
2	Primary Fibre Channel I/O module
3	System information panel
4	SCSI I/O module, bus 0
5	Power supplies
6	Additional SCSI I/O module slot, bus 1
7	Redundant Fibre Channel I/O module slot
8	Fan modules
9	Additional SCSI I/O module slots, buses 2 and 3
10	2-Gb Small Form Factor Pluggable (SFP) Transceiver

MSA1000



The MSA1000 is a 2 Gb Fibre Channel entry-level to mid-range SAN storage system scalable to 12TB. It is designed to reduce the complexity, expense and risk of deploying high-performance shared storage.

Key features of the MSA1000:

- Modular design to grow as the needs demand
- Enterprise-class SCSI storage
- Easy migration of existing drives and data
- Supports two MSA30 per MSA1000 box
- Offers highest level of fault tolerance (RAID 6)

MSA1000 Overview

The HP StorageWorks 1000 Modular Smart Array (MSA1000) is a 2 Gb Fibre Channel storage system for the entry-level to midrange storage area network (SAN). It provides the customer with a low-cost, scalable, high performance storage consolidation system with investment protection. It is designed to reduce the complexity and risk of SAN deployments. The powerful but easy to use management software makes it ideal for departmental and remote location SANs. The ability to easily move most data, disks, and enclosures currently directly attached to Smart Array controllers (DAS) to a shared storage environment (SAN) will save the user both money and time. With the addition of two more drive enclosures, it can control up to 42 drives allowing capacity of twelve terabytes. All configuration, management and partitioning and licensing software come standard with no extra charges.

HP's exclusive optional embedded 8-port SAN switch or 3-port hub give cost effective and space saving methods of creating a SAN environment. In addition it is qualified on any of the external B-series, M-series and C-series FC switches.

MSA1000 Features

Two views of the MSA1000 are shown, with the key components identified.

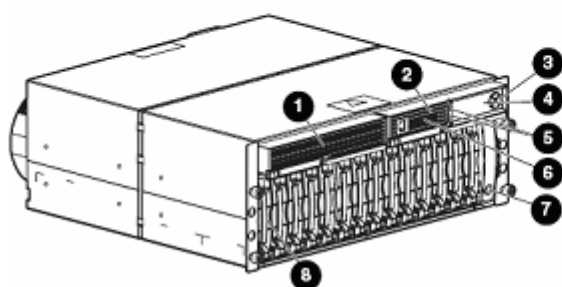

MSA1000 (Front View)

Reference #	Identifier
1	Redundant Controller Slot Blank
2	Primary MSA1000 Controller
3	Display Buttons
4	Display Panel
5	Display Indicators
6	Status Indicators
7	Power Switch
8	Power Bay(s)

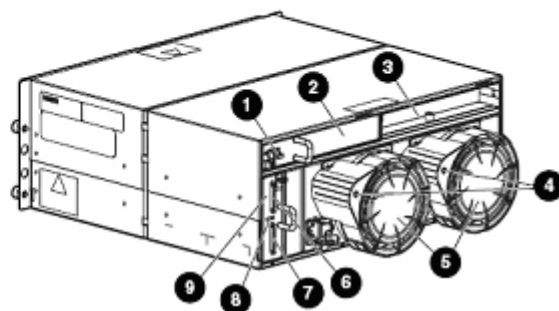

MSA1000 (Rear View)

Reference #	Identifier
1	2-Gb Small Form Factor Pluggable (SFP) Transceiver
2	Fibre Channel I/O Module
3	Redundant Fibre Channel I/O Module Slot (Blank)
4	Power Supply Indicators
5	Blowers Attached to Power Supply
6	SCSI Expansion Port A
7	SCSI Expansion Port B
8	Environmental Monitoring Unit Indicators
9	Environmental Monitoring Unit

MSA30



The MSA30 provides scalability and performance at a reduced cost with a high return on investment, and with the ability to manage more data with less staffing and increased computing infrastructure utilization for better overall system performance.

Key features of the MSA30:

- Affordable capacity
- Easy deployment
- Investment protection
- Increases storage density when used with MSA1000 and MSA1500

MSA30 Overview

The HP StorageWorks Modular Smart Array 30 Enclosure family is the newest HP Ultra320 SCSI disk drive storage enclosure, delivering industry-leading data performance, availability, storage capacity and upgradeability to meet the demanding and growing storage needs.

The MSA30 Enclosure is ideal for data center, departmental and workgroup server users who need a flexible, universal storage enclosure that utilizes a common storage building block for their current and future data center. The MSA30 Enclosure is intended for use with servers delivering business-critical data and applications with requirements for high availability, performance, excellent serviceability, and large storage capacity.

MSA20



The MSA20 provides scalability and performance at a reduced cost with a high return on investment, and with the ability to manage more data with less staffing and increased computing infrastructure utilization for better overall system performance.

Key features of the MSA20:

- Affordable capacity
- Easy deployment
- Investment protection
- Increases storage density when used with MSA1500

MSA20 Overview

The HP StorageWorks Modular Smart Array 20 Enclosure (MSA20) is a SATA 1.5 Gb/s disk drive storage enclosure with Ultra320 SCSI host connectivity. These enclosures deliver industry-leading availability, storage density, and upgradeability to meet customers' demanding and growing storage needs. The MSA20 delivers the ideal mix of low-cost and high capacity, for minimum I/O workloads such as reference data, archival, and disk-to-disk backup.

MSA support for SCO Operating Systems – Supported Components

Hardware

The hardware listed below is supported with MSA1000 and MSA1500 on SCO UnixWare and OpenServer operating system unless noted.

ProLiant Servers	
Please check the HP products and services ProLiant Server OS Support Matrix for more detailed server support information for SCO Operating systems and the Server QuickSpecs for MSA1000 / MSA1500 support.	
Host Bus Adapter	Host Bus Driver
<ol style="list-style-type: none"> HP StorageWorks FCA2214 (P/N: 283384-001) HP StorageWorks FCA2214DC (P/N: 321835-B21) <p>FCA2214/FCA2214DC is 2-Gbps Fibre Channel to PCI-X Host Bus Adapter that provides operating system connectivity support for the HP StorageWorks storage array family.</p> <p>HBA is branded and marketed under different names. Use the latest BIOS for HBA available at www.hp.com.</p> <p><i>NOTE: hp ProLiant Servers recognize FCA2214 and FCA2214DC controllers in the following way:</i></p> <ol style="list-style-type: none"> At POST: "QLA2312 PCI Fibre Channel" In RBSU: "QLogic 2340/2342, 64Bit/133MHz PCI-X to FC 2GB HBA" 	<p>qlc2300 – Qlogic QLC2300 Fibre Channel HBA Driver</p> <p>Use the driver available on the OS media or download the latest version from http://www.sco.com/support/download.html</p>
Storage	Connectivity requirements
<ol style="list-style-type: none"> HP StorageWorks Modular Smart Array 1500 cs (P/N: AA986A) Single Controller (Active/Passive) : Firmware Version: 4.96b or higher Dual Controller (Active/Active): Firmware Version: 6.86 or higher HP StorageWorks Modular Smart Array 1000 (P/N: 201723-B22) Firmware Version: 4.94 or higher HP StorageWorks Modular Smart Array 20 (P/N: 335921-B21) Firmware Version: 1.28 or higher HP StorageWorks Modular Smart Array 30 (P/N: 302969-B21) Firmware Version: CP20 or higher 	<ol style="list-style-type: none"> HP MSA SAN Switch 2/8 (P/N: 288247-B21) HP MSA Hub 2/3 (P/N: 286763-B21) StorageWorks Fibre channel Storage Hub 12 (P/N: 295573-001) Brocade Silkorm 2040 SAN switch

Software

Listed below are the software requirements to support MSA1000 and MSA1500 unless noted.

Operating System	HP EFS
<ol style="list-style-type: none">1. SCO OpenServer 6.0.02. SCO UnixWare 7.1.33. SCO UnixWare 7.1.4 <p>Use the latest Maintenance Pack available at http://www.sco.com/support/download.html</p>	hp ProLiant Extended Feature Supplement (EFS) for SCO UnixWare 7 and SCO OpenServer 6 version 7.70A or later.
Configuring MSA1000 & MSA1500	
<p>MSA1000 & MSA1500 ship with a CD containing HP Array Configuration Utility (ACU). The HP Array Configuration Utility software for Smart Array controllers and the StorageWorks Enclosure products makes it easy to configure and expand your disk drive arrays.</p> <p>NOTE: Online ACU is not available for SCO Operating Systems.</p> <p>MSA1000 & MSA1500 can also be configured using Command Line Interface (CLI). For more information on CLI setup and usage, refer to the CLI user guide available at http://h20000.www2.hp.com/bc/docs/support/SupportManual/c00149849/c00149849.pdf</p>	

Firmware Upgrade for MSA1000 and MSA1500

Firmware on the MSA1000 and MSA1500 controllers can be upgraded in the following ways:

- 1. Using offline firmware update CD** – a bootable CD containing firmware update for MSA1000 and MSA1500 controllers. Boot the ProLiant server with MSA attached using this CD and follow the on-screen instructions. Go to the web site for your MSA for obtaining the latest controller firmware files:

MSA1000: <http://www.hp.com/go/msa1000>

MSA1500: <http://www.hp.com/go/msa1500cs>

- 2. Using CLI interface of MSA1000/MSA1500** – Refer to the section titled **“Updating MSA controller firmware”** in **“HP StorageWorks Modular Smart Array 1000/1500 Firmware updating guide”** available under **“Technical documentation”** page for MSA1000/MSA1500.

MSA Deployment

Deploying the MSA1000/MSA1500 in a SCO Operating System environment involves:

Place a checkmark (✓) in the box after completing each step.

✓	Item	Comments	✓
<input type="checkbox"/>	Connecting the ProLiant server running SCO operating system		
<input type="checkbox"/>	Configuring logical volumes on the MSA		
<input type="checkbox"/>	Installing the HBA driver on the SCO servers		
<input type="checkbox"/>	Identifying logical volumes to the SCO operating system		
<input type="checkbox"/>	MSA maintenance		

Connecting MSA to ProLiant servers running SCO operating systems

✓	Item	Comments	✓
<input type="checkbox"/>	Direct Attach		
<input type="checkbox"/>	Internal Hub		
<input type="checkbox"/>	Internal switch		
<input type="checkbox"/>	External switch		

The following diagrams illustrate these connectivity types

Figure 1. Single Server (Single Path) using the Fibre Channel I/O Module (Direct)

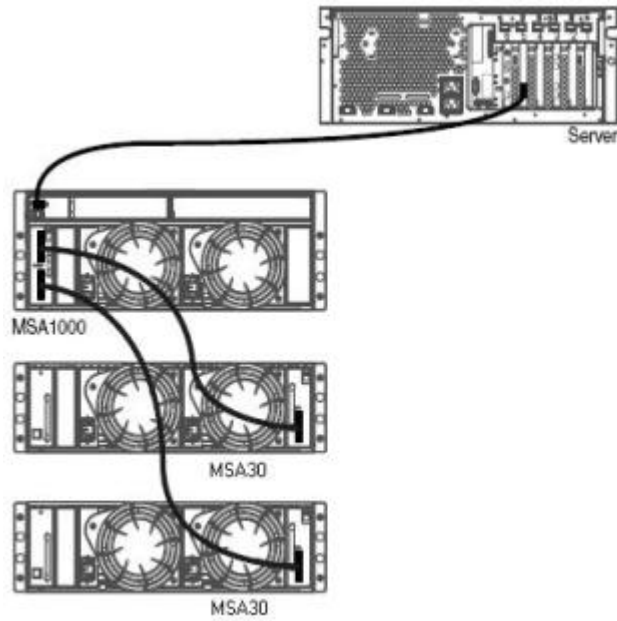

Figure 2. A Typical MSA1000 Configuration using MSA SAN Switch 2/8

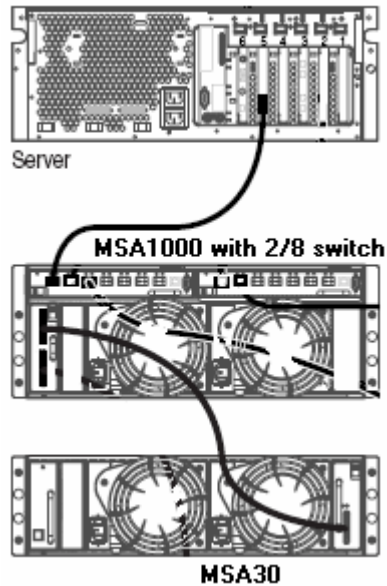

Figure 3. A Typical Configuration with a Server and MSA1000 using MSA Hub 2/3

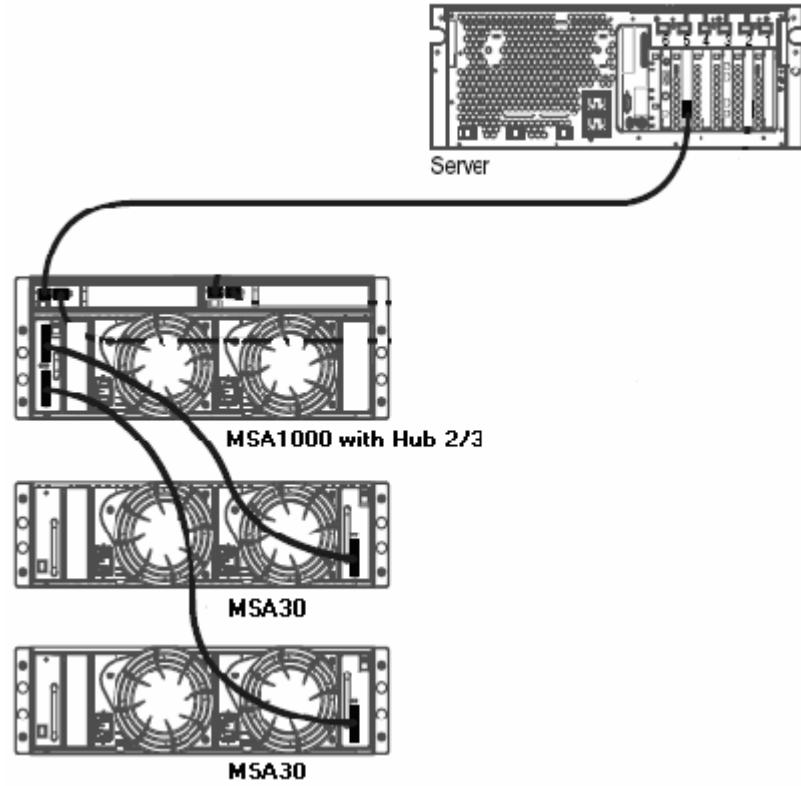

Figure 4. A Typical Single-Path Configuration

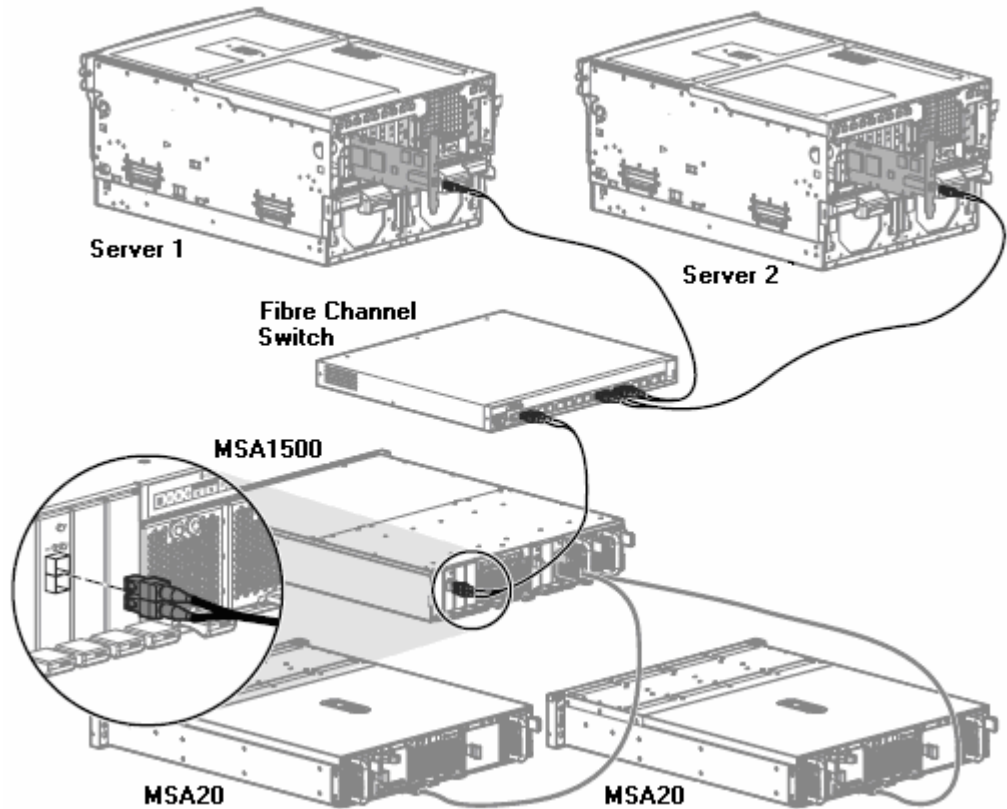
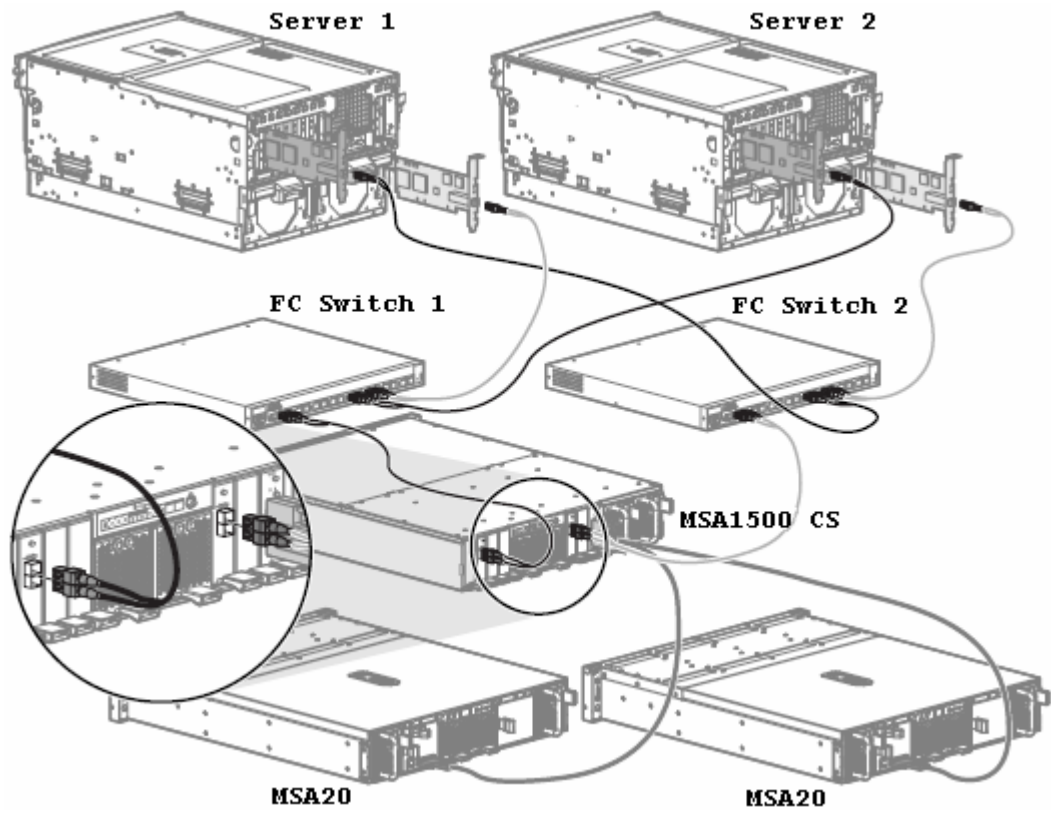

Figure 5. A Typical Multi-Path Configuration



Configuring logical volumes on the MSA

The LUNs on MSA1000/MSA1500 can be configured using Command Line Interface (CLI) or the ACU utility.

✓ Item	Comments	✓
<input type="checkbox"/> Creating LUNs using CLI	HP StorageWorks Modular Smart Array (MSA) Command Line Interface document available at http://h20000.www2.hp.com/bc/docs/support/SupportManual/c00149849/c00149849.pdf provides information to use the Command Line Interface. In order to use the CLI interface, a serial connection needs to be setup to the MSA1000/MSA1500 controller. Refer to the CLI setup section in the Interface document. Create the LUNs as described in the "Creating LUNs" section in the Interface document.	
<input type="checkbox"/> Creating LUNs using ACU	The Array Configuration Utility can be used to create the LUNs on a MSA. This utility is available on a bootable CD that is shipped with MSA1000/MSA1500. Boot the ProLiant server with the MSA attached using this CD. Follow the on-screen instructions to create LUNs.	

Installing the HBA Driver

✓ Item	Comments	✓
<input type="checkbox"/> Install the SCO Operating System on a ProLiant server.	Refer to the SCO Operating System Deployment Guide for OS installation tips on ProLiant platforms. Update the system with latest Maintenance Pack for OS. Install the HP ProLiant Extended Feature Supplement for SCO UnixWare 7 and OpenServer 6 version 7.70A or later.	
<input type="checkbox"/> Driver Software	<p>qlc2300 Host Bus Adapter (HBA) Driver Supplement (version 8.0.3) for SCO OpenServer 6.0.0 is available on the SCO OpenServer 6.0.0 installation media.</p> <p>For SCO UnixWare 7.1.3 and SCO UnixWare 7.1.4, use the latest version of qlc2300 Host Bus Adapter driver available at http://www.sco.com/support/update/download/release.php?rid=25</p>	
<input type="checkbox"/> Creating HBA Diskette	<p>In order to create HBA diskette from image hba.qlc2300.83a.image, perform the following steps (applicable for SCO UnixWare 7.1.3/7.1.4 only):</p> <p>Login as root on a SCO Unix system and perform the following:</p> <pre>\$ su Password: <type your root password> # mkdir /tmp/hba # cd /tmp/hba</pre> <p>Download the hba.qlc2300.83a image file to the newly created /tmp/hba directory on your machine.</p> <p>Insert a formatted floppy in to the floppy drive and execute the following command to create qlc2300 diskette from the image file:</p> <pre># dd if= hba.qlc2300.83a.image of=/dev/dsk/f0t bs=36b</pre>	
<input type="checkbox"/> Installation of HBA Drivers	<p>On a SCO UnixWare 7.1.3/7.1.4 system, the qlc2300 diskette can be used to install/upgrade the qlc2300 driver on your system.</p> <p>Insert HBA diskette and execute the command:</p> <pre># pkgadd -d diskette1 all</pre> <p>or</p> <pre># pkgadd -d diskette1 qlc2300</pre> <p>On SCO OpenServer 6.0.0 system, qlc2300 driver (version 8.0.3) available on the OS media can be used to install the driver.</p> <p>Insert SCO OpenServer 6.0.0 OS installation media into the CD-ROM drive and perform the following:</p> <ol style="list-style-type: none"> 1. Login as "root" 2. At # prompt, type the following and press ENTER: <pre># pkgadd -d cdrom1 qlc2300</pre> 	

Configuring MSA LUNs in SCO Operating System

✓ Item	Comments	✓
<input type="checkbox"/> Identifying Logical Volumes to the Operating System	<p>To identify the logical volumes configured on MSA1000/MSA1500, login as root on any SCO Unix system with the MSA1000/MSA1500 attached and run "sdiconfig -l". This command will list all the Host Bus Adapters, MSA1000/MSA1500 controller and the configured LUNs.</p> <p>The QLogic controller, MSA1000 and its LUN's will be listed as:</p> <pre>C:B,T,L: HBA : (qlc2300,N) QLogic QLA2300 B,T,L: RAID: COMPAQ MSA1000 4.94 B,T,L: DISK: COMPAQ MSA1000 VOLUME 4.94</pre> <p>Where</p> <ul style="list-style-type: none"> 'C' – the Controller 'B' – the Bus 'T' – the Target 'L' – the Logical Unit Number 'N' – the instance assigned by the qlc2300 driver to each HBA <p>A typical output of this command with the MSA1000 attached:</p> <pre># sdiconfig -l 0:0,31,0: HBA : (ciss, 1) hp ProLiant CISS 0,0,0: DISK : HP LOGICAL VOLUME 2.58 1,31,0: HBA : (ciss, 1) hp ProLiant CISS 2,31,0: HBA : (ciss, 1) hp ProLiant CISS 1:0,2,0: HBA : (ide, 1) Generic IDE/ATAPI 0,0,0: CDROM : COMPAQ CD-224E A.8D 3:0,7,0: HBA : (qlc2300, 1) QLogic QLA2300 ← HBA# 0,0,0: RAID : COMPAQ MSA1000 4.94 ← Controller 0,0,1: DISK : COMPAQ MSA1000 VOLUME 4.94 ← LUN1 0,0,2: DISK : COMPAQ MSA1000 VOLUME 4.94 ← LUN2 0,0,3: DISK : COMPAQ MSA1000 VOLUME 4.94 ← LUN3 1,7,0: HBA : (qlc2300, 1) QLogic QLA2300 2,7,0: HBA : (qlc2300, 1) QLogic QLA2300 3,7,0: HBA : (qlc2300, 1) QLogic QLA2300 4,7,0: HBA : (qlc2300, 1) QLogic QLA2300 5,7,0: HBA : (qlc2300, 1) QLogic QLA2300 6,7,0: HBA : (qlc2300, 1) QLogic QLA2300 7,7,0: HBA : (qlc2300, 1) QLogic QLA2300</pre> <p>SCO UnixWare7 "diskadd" command could be used to add the missing configured MSA1000 LUNs that are not listed by the "sdiconfig" command.</p> <p>Using SCO UnixWare7 "fdisk" command, one can create and modify the LUN partition table. Typical usage of this command is:</p> <pre># fdisk /dev/rdisk/cCbBtTDs0</pre> <p>Using SCO UnixWare7 "disksetup" command, the LUNs can be configured to create and mount the file systems. "disksetup" performs the low level activities required to install the primary drive or additional drives. The tasks required for disk setup include surface analysis, that will assist in creating the</p>	

layout of slices (either through a set of defaults or by asking for details), writing the pinfo, VTOC and alternates tables out to the drive, issuing needed *mkfs* calls, creating mount points, mounting filesystems, and updating the */etc/vfstab* file. Typical usage of this command is:

```
# disksetup -le /dev/rdisk/cCbBtTdDs0
```

The intended Controller (C), Bus (B), Target (T) and disk (D) parameters need to be specified appropriately with this command.

Using SCO OpenServer 6.0.0 "*mkdev hd*", one can create filesystems on MSA1000/MSA1500 LUNs. "*mkdev hd*" presents a list of disks identified on the system running SCO OpenServer 6.0.0. Select the disk to configure and follow the prompts. "*mkdev hd*" process takes you through "*fdisk*" program to create partitions on the selected disk and "*divvy*" program to create slices and filesystems on the selected disk.

Limitations

UnixWare 7/OpenServer 6

1. Maximum of two (2) servers per cluster
2. MSA1000 Redundancy
3. MSA1000 Multi-path
4. Online configuration of MSA1000/MSA1500 LUNs
5. Online Firmware upgrade of MSA1000/MSA1500
6. Event logging of MSA1000/MSA1500
7. Systems Management support for MSA1000/MSA1500

For more information

MSA1500 website at <http://www.hp.com/go/msa1500cs>

MSA1000 website at <http://www.hp.com/go/msa1000>

MSA30 website at <http://www.hp.com/go/msa30>

MSA20 website at

<http://h18004.www1.hp.com/products/servers/proliantstorage/sharedstorage/sacluster/msa20/index.html>

© Copyright 2001-2006 Hewlett-Packard Development Company, L.P.

Hewlett-Packard Company makes no warranty of any kind with regard to this material, including, but not limited to, the implied warranties of merchantability and fitness for a particular purpose. Hewlett-Packard shall not be liable for errors contained herein or for incidental or consequential damages in connection with the furnishing, performance, or use of this material.

This document contains proprietary information, which is protected by copyright. No part of this document may be photocopied, reproduced, or translated into another language without the prior written consent of Hewlett-Packard.

The information contained in this document is subject to change without notice.

UNIX® is a registered trademark of The Open Group.

Hewlett-Packard Company shall not be liable for technical or editorial errors or omissions contained herein. The information is provided "as is" without warranty of any kind and is subject to change without notice. The warranties for Hewlett-Packard Company products are set forth in the express limited warranty statements for such products.

Nothing herein should be construed as constituting an additional warranty.

413487-001aEN, 06/2006

